

G-Type

# Brusesystem

**Artikel nr.:** 726000000  
**Overflade:** Krom  
**Serie:** G-Type

**VVS Nr.:** 722207604  
**EAN Nr.:** 5708516610014



## UDBUDSBESKRIVELSE

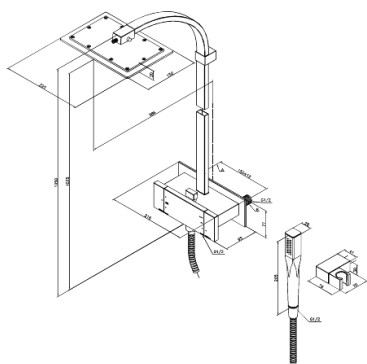

**FM Mattsson Denmark ApS**  
Hvidkærvej 48, 5250 Odense SV, CVR 56416218

Tlf.: 88 33 00 34 [danmark@fmmattssongroup.com](mailto:danmark@fmmattssongroup.com)

Mere information på [damixa.dk](http://damixa.dk)

**damixa**